

SR-EOH Horizontal Energy Storage System

User Manual

V1.5

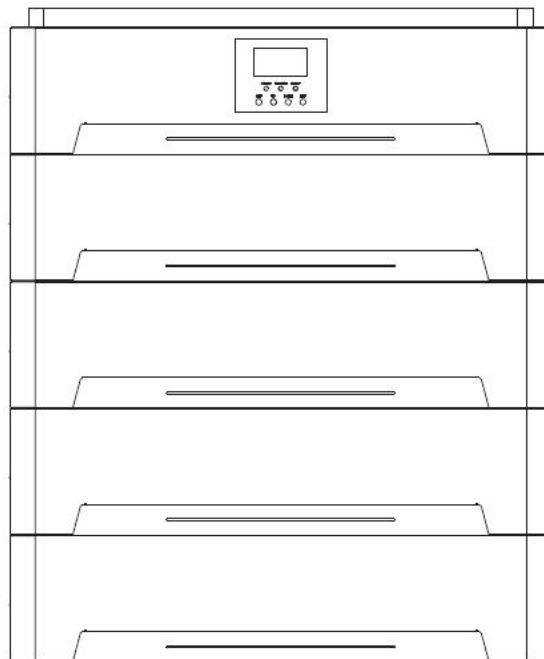

1. Instructions

Thank you very much for choosing the EOH series household energy storage system developed and produced by our company. Please read and understand all contents of the Manual carefully before installing and using the product. If you have any suggestions during the use, please do not hesitate to give us feedback.

1.1 Range of Application

The installation and user manual of SR-EOH series is applicable to the installation and use of the following products:

No	Applicable to the countries with 220V mains voltage	Applicable to the countries with 110V mains voltage
1	SR-EOH48-5.0S-S1	SR-EOH48-5.0U-S1
2	SR-EOH48-10.0S-S1	SR-EOH48-10.0U-S1
3	SR-EOH48-15.0S-S1	SR-EOH48-15.0U-S1
4	SR-EOH48-20.0S-S1	SR-EOH48-20.0U-S1

The product should be used in compliance with local standards, laws and regulations, because any non-compliance with the use may lead to personal injuries and property loss.

The drawings provided in this Manual are used to explain the concepts related to the product, including product information, installation guide, electrical connection, system debugging, safety information, common problems and maintenance, etc.

The internal parameters of this product have been adjusted before delivery. No internal parameters can be changed without permission. Any unauthorized changes to the settings will invalidate the warranty, and the Company will not be liable for any loss resulting therefrom.





This Manual and other related documents are an integral part of the product and should be kept properly for onsite installation personnel and related technical personnel to consult.

1.2 Meaning of Abbreviations

AC	Alternating Current
DC	Direct Current
PV	Photovoltaic
BMS	Battery Management System
PCS	Power Conversion System
RJ45	Registered Jack 45
SOC	State Of Charge
C	Charge C-rate
RS485	RS485 Communication Interface
CAN	Controller Area Network

1.3 Symbol Stipulations









There may be following symbols herein, and their meanings are as follows.

Symbols	Description
	Indicate a hazard with a high level of risk which, if not avoided, will result in death or serious injuries.
	Indicate a hazard with a medium level of risk which, if not avoided, could result in death or serious injuries.
	Indicate a hazard with a low level of risk which, if not avoided, could result in minor or moderate injuries.
	Warning information about device or environment safety. If not avoided, equipment damage, data loss, performance degradation or other unanticipated results may be resulted in. The "NOTICE" does not involve any personal injuries.

2 Safety Precautions

2.1 Safety Symbols

This product contains the following symbols, please pay attention to identifying.

Symbols	Description
	Observe enclosed documentation
	Danger. Risk of electric shock!
	Danger of high voltages. Danger to life due to high voltages in the Energy storage system
	Hot surface
	CE certification
	Do not touch the product in 5mins after shutdown
	Comply with RoHS standard
	The Energy storage system should not be disposed together with the household waste.

2.1 General Safety





2.1.1 Important Notice





Before installing, operating and maintaining the device, please read this Manual first and follow the symbols on the device and all the safety precautions in this Manual.

The matters indicated with "DANGER", "CAUTION", "ATTENTION" and "NOTICE" in this Manual do not represent all the safety matters to be observed, but are only the supplements to all the safety precautions. The Company will not be liable for any violation of general safety operating requirements, or any violation of safety standards for the design, production and use of the device. The device must be used in an environment that meets the requirements of the design specifications. Otherwise, the device may fail, and the abnormal device function or component damage, personal safety accident, and property loss arising from this are not covered within the quality assurance scope of the device. When installing, operating, and maintaining the device, the local laws, regulations, and codes shall be followed. The safety precautions in this Manual are only supplements to local laws, regulations, and codes. The Company shall not be liable for any of the following circumstances.

- The device is not run under the conditions of operating described in this Manual.
- The installation and operating environment is beyond the requirements of relevant international or national standards.
- The product is disassembled or changed, or the software code is modified without authorization.
- The operation instructions and safety warnings related with the product and in the documents are not followed.
- Damage of the device is caused by abnormal natural environment (force majeure, such as earthquake, fire, and storm).
- Transportation damage is caused during customer's own transportation.
- The storage condition does not meet the requirements of the product related documents and causes damage.

2.1.2 General Requirements

	Operating when the power is on is strictly prohibited during installation.
	It is strictly prohibited to install, use, and operate any outdoor equipment or cables (including but not limited to transporting equipment, operating equipment and cables, plugging and removing signal ports connected to the outdoor, working at altitude, and outdoor installation) in severe weather, such as thunder, rain, snow, and gale level 6.
	In case of any fire, evacuate the building or equipment area and press the fire alarm bell or dial the fire call. Under any circumstances, re-entry into a burning building is strictly prohibited.
	Under no circumstances should the structure and installation sequence of the device be changed without the manufacturer's permission.

	<p>The battery terminal components shall not be affected during transportation. And, the battery terminal bolts shall not be lifted or transported.</p>
	<p>It is strictly prohibited to alter, damage or block the marks and nameplates on the device.</p>
	<p>The composition and working principle of the entire photovoltaic power generation system, as well as the relevant standards of the country/region where the project is located shall be known fully.</p>
	<p>After the device is installed, the empty packing materials, such as cartons, foam, plastics, and cable ties, shall be removed from the device area.</p>

2.1.3 Personnel Safety

- When operating the device, appropriate personal protective equipment shall be worn. If any fault that may lead to personal injury or damage of the device is found, immediately terminate the operation, report to the responsible person, and take effective protective measures.
- Before using any tools, learn the correct method of using the tool to avoid injuries and damage of the device.
- When the device is running, the temperature of the case is high, which may cause burns. Therefore, do not touch the case.
- In order to ensure personal safety and normal use, reliable grounding should be carried out before use.
- Do not open or damage the battery. The electrolyte released is harmful to skin and eyes, so avoid touch it.
- Do not place irrelevant items on the top of the device or insert them into any part of the device.
- Do not place flammable items around the device.
- Never place the battery in the fire to avoid explosion and prevent the personal safety from being endangered.
- Do not place the battery module in water or other liquids.
- Do not short-circuit the battery terminals, because short-circuiting of the battery may cause combustion.
- The battery may pose a risk of causing electric shocks and large short-circuit currents. When using the battery, the following precautions should be paid attention to:
 - a) The metal objects, such as watch and rings, shall be removed.
 - b) Tools with insulated handles should be used.
 - c) Rubber gloves and shoes should be worn.
 - d) The charging power supply shall be disconnected before connecting or disconnecting terminals of the battery.
 - e) Check whether the battery is accidentally grounded. If the battery is accidentally grounded, remove the power supply from the ground.
- Do not clean the internal and external electrical components of the cabinet with water or detergent.

- Do not stand, lean or sit on the device.
- Do not damage any modules of the device.

2.2 Personnel Requirements

- The personnel in charge of installation and maintenance must be strictly trained to understand all safety precautions and master proper operation methods.
- Only qualified professionals or trained personnel are allowed to install, operate and maintain the device.
- The personnel who operate the device, including the operators, trained personnel and professionals, must have special operation qualifications required by the local country, such as high voltage operation, working high above the ground, and special equipment operation qualification.
- The replacement of device or components (including software) must be carried out by professionals or authorized personnel.

2.3 Electrical Safety

2.3.1 General Requirements



Before carrying out electrical connections, ensure that the device is not damaged, or an electric shock or fire may occur.



Never install or remove any power cables when the power is on. The electric arcs or sparks may be generated at the moment when the power cable contacts with the conductor, which may cause fire or personal injuries.

- All the electrical connections must meet the electrical standards of the country/region where the project is located.
- The cables prepared by users themselves shall comply with local laws and regulations.
- Special insulating tools should be used in high-voltage operations.
- Before connecting the power cord, ensure that the label identification on the power cord is correct.
- Operations on the device are allowed only five minutes after the device is completely powered off.
- The insulation layer of the cable may be aged or damaged when the cable is used in a high temperature environment. Therefore, the distance between the cable and the heat source must be at least 30mm.
- Cables of the same type should be bundled together. Whereas, the cables of different types should be routed at least 30mm apart, and shall not be wrapped together or crossed.

2.3.2 Grounding Requirements

- When installing the device to be grounded, the protective grounding wire must be installed first; when removing the device, the protective grounding wire must be removed at last.
- It is forbidden to destroy the grounding conductor.
- It is forbidden to operate the device without a grounding conductor installed.
- The device shall be permanently connected to the protective grounding wire. Before operating the device, electrical connection of the device shall be checked to ensure that the device is reliably grounded.

2.4 Installation Environment Requirements

- This product is for indoor use only, and is strictly prohibited to be used in outdoor environment.
- Do not install or use this product in an environment where the temperature is lower than $-10\text{ }^{\circ}\text{C}$ or higher than $50\text{ }^{\circ}\text{C}$.
- It should be installed in a dry and well-ventilated environment to ensure good heat dissipation performance.
- The product can be installed at a maximum altitude of 2,000m.
- The installation position should be away from the fire source.
- The product should be installed and used away from children and animals.
- The installation position should be far away from water sources, such as faucets, sewer pipes, and sprinklers, to avoid entering of water.
- The device should be placed on a firm and flat supporting surface.
- Do not place any inflammable or explosive items around the device.
- When the device is running, do not block the ventilation vent or heat dissipation system to prevent fire caused by high temperature.



The operation and service life of the energy storage is related to the operating temperature. The energy storage should be installed at a temperature equal to or better than the ambient temperature.



Max+50°C



Min-10°C



RH.+5%~+95%



3 Product Introduction

3.1 Brief Introduction to Product

SR-EOH is a new generation of household energy storage system with two output specifications of 220V and 110V, which can meet the diversified needs of global users. The SR-EOH energy storage system adopts a modular design, including power modules and battery expansion modules, so it can be easily combined into a system of any capacity required by the user.

The lithium iron phosphate batteries with high performance and long service life are used in the energy storage module. Meanwhile, the modular structure design is adopted. Each energy storage module is internally integrated with the intelligent BMS system, which can be easily expanded and can be combined into 20Kwh battery pack at most.

The brand new topological circuit design is adopted in the power module, which can realize the energy exchange between photovoltaic, mains, battery and loads, and has the function of photovoltaic and mains charging. The photovoltaic charging module adopts the latest optimized MPPT tracking technology, which can quickly track the maximum power point of the photovoltaic array in any environment, and obtain the maximum energy of the solar panel in real time. In addition, MPPT has a wide voltage range. The advanced control algorithm is adopted in the mains charging module to realize the fully-digital double closed-loop control of voltage and current, so the control precision is high and the volume is small. The AC voltage input range is wide, and the input/output protection functions are complete, which can realize the stable and reliable charging and protection of batteries. The inverter module is based on the full-digital intelligent design, adopts the advanced SPWM technology, outputs pure sine wave, converts direct current into alternating current, and is applicable for household appliances, power tools and other AC loads.

The typical topological diagram for application of the system is as follows:

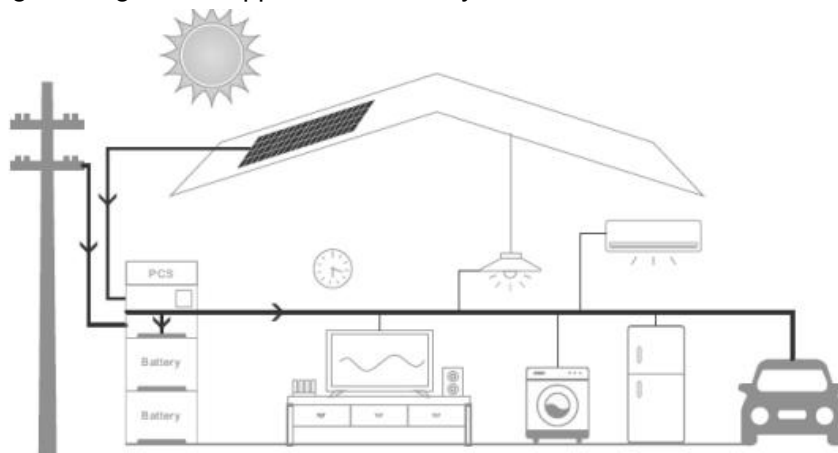

3.2 Model Coding

The model coding of the energy storage system is as follows:

SR-EOH48-5.0U-S 0
 ① ② ③ ④ ⑤ ⑥

Identifier	Meaning	Value
①	Product type	EOH: horizontally-mounted EOV: vertically-mounted EOS: wall-mounted
②	System voltage	24: 24V system 48: 48V system
③	Energy storage capacity level	5.0: The system capacity is 5kWh 10.0: The system capacity is 10kWh
④	Output voltage	U: The output voltage is 110V S: The output voltage is 220V
⑤	Product category	S: Energy storage system E: Energy storage battery module C: Power conversion module
⑥	Version number	0: Version 0

The model coding of the power module is as follows:

SR-EOH48-5.0U-C 0
 ① ② ③ ④ ⑤ ⑥

Identifier	Meaning	Value
①	Product type	EOH: horizontally-mounted EOV: vertically-mounted EOS: wall-mounted
②	System voltage	24: 24V system 48: 48V system
③	Output power level	5.0: The system capacity is 5kW 10.0: The system capacity is 10kW
④	Output voltage	U: The output voltage is 110V S: The output voltage is 220V
⑤	Product category	C: Power module
⑥	Version number	0: Version 0

The model coding of the energy storage battery is as follows:

SR-EOH48-5.0A-E 0
 ① ② ③ ④ ⑤ ⑥

Identifier	Meaning	Value
①	Product type	EOH: horizontally-mounted EOV: vertically-mounted EOS: wall-mounted
②	System voltage	24: 24V system 48: 48V system
③	Energy storage capacity level	2.5: The system capacity is 2.5kWh 5.0: The system capacity is 5kWh
④	Energy storage battery type	A: Lithium iron phosphate (LiFePO4)
⑤	Product category	E: Energy storage battery
⑥	Version number	0: Version 0

3.3 Description of Energy Storage Capacity

SR-EOH series energy storage system supports the capacity expansion with up to four energy storage modules.

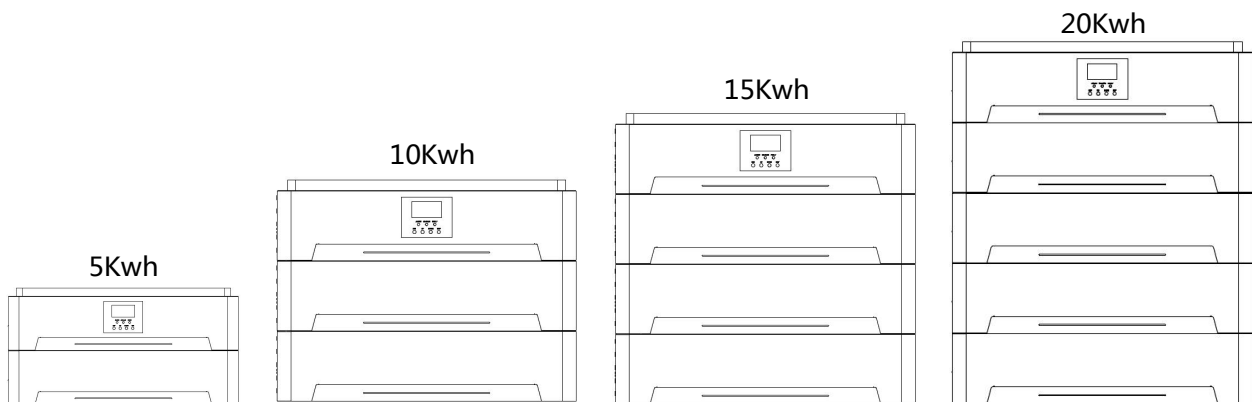

3.4 Appearance Description

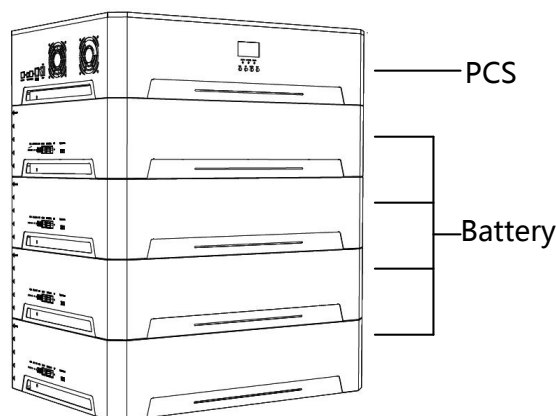

3.4.1 Power Conversion System Module

The power of power conversion system is 5KW.

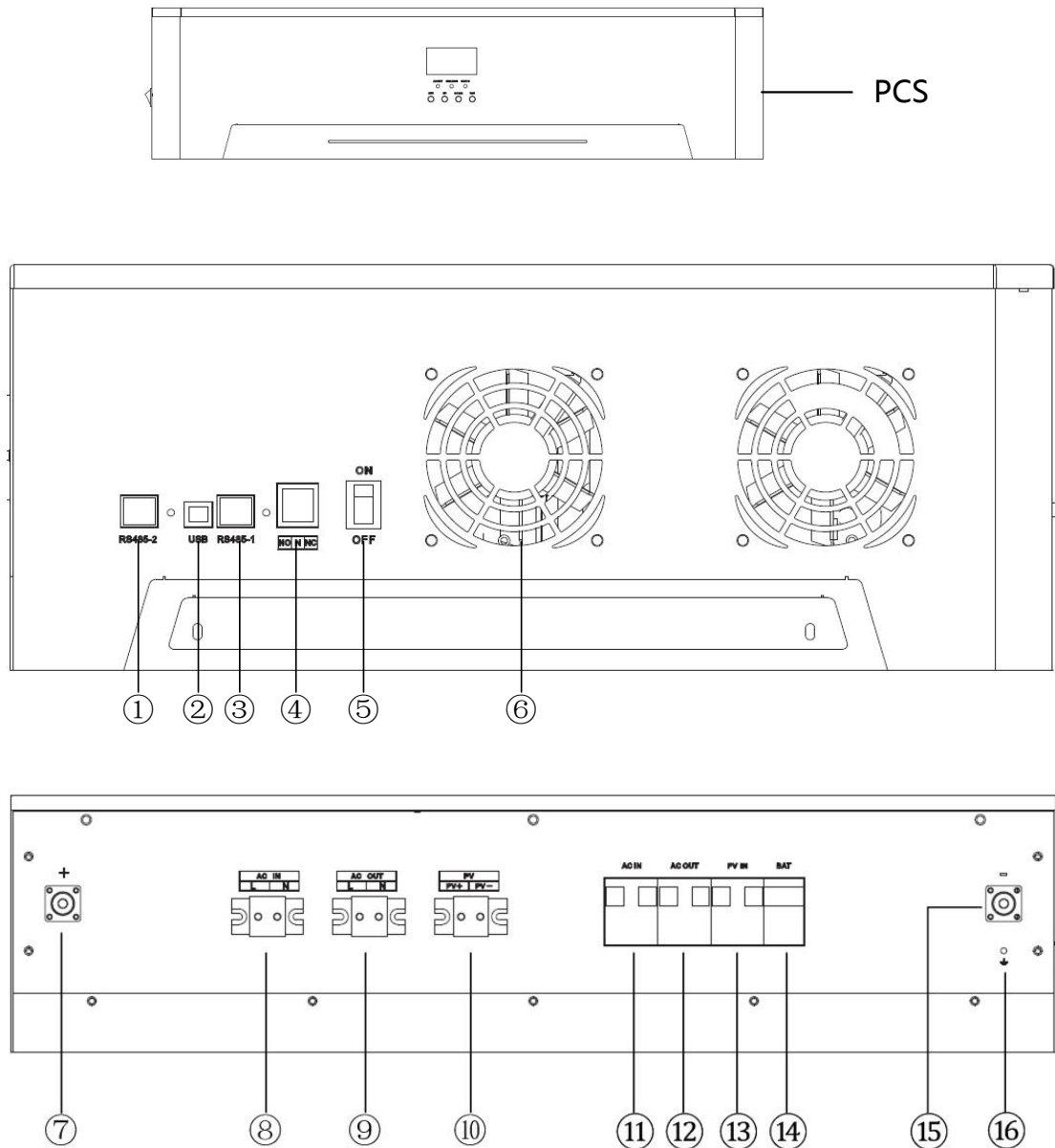

① RS485-2	② USB	③ RS485-1	④ Dry contact
⑤ PCS ON/OFF	⑥ Cooling fan	⑦ Battery Positive	⑧ AC input port
⑨ AC output port	⑩ PV input port	⑪ AC input switch	⑫ AC output switch
⑬ PV input switch	⑭ Battery switch	⑮ Battery Negative	⑯ Grounding screw hole

3.4.2 Energy Storage Battery Module

The voltage of a single battery is 48V and the capacity is 100Ah.

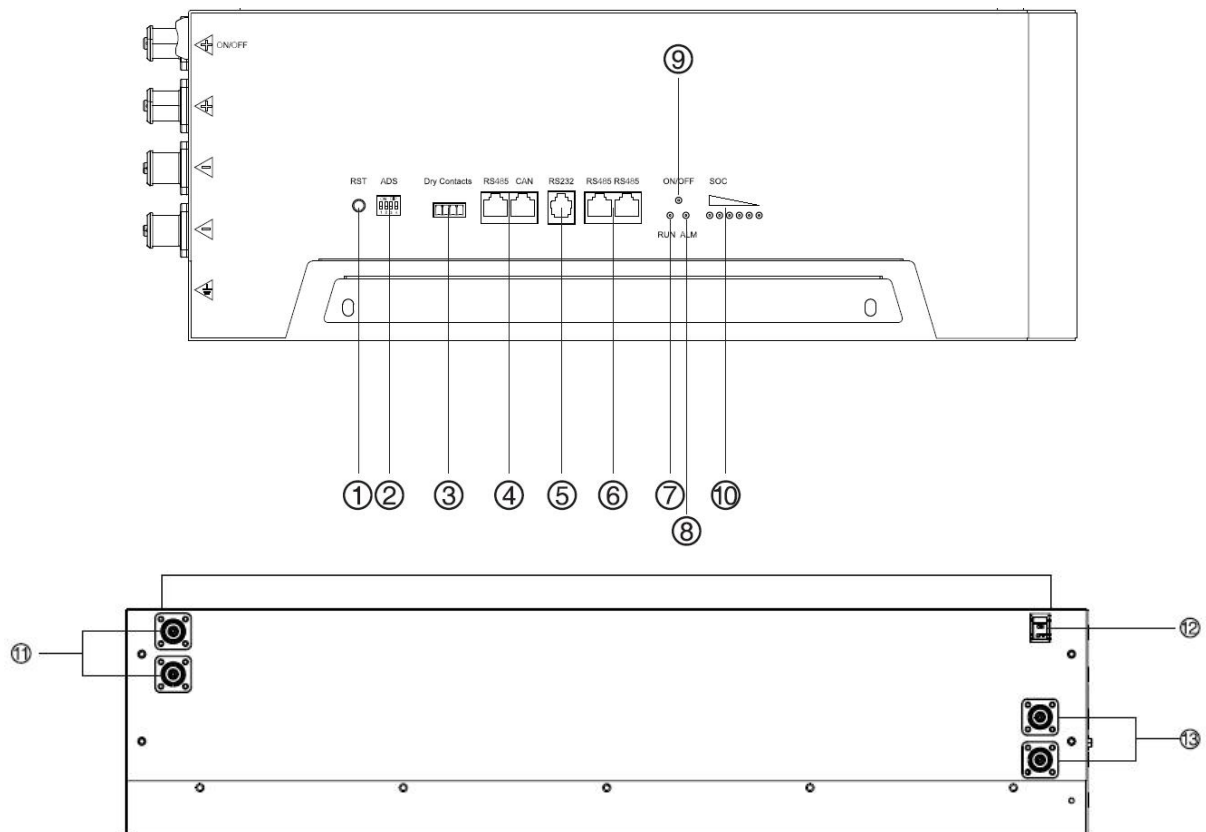
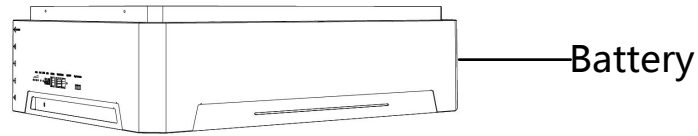

① Reset	② Address	③ Dry contact	④ RS485/CAN
⑤ RS232	⑥ RS485/RS485	⑦ LED(RUM)	⑧ LED(ALARM)
⑨ LED(ON/OFF)	⑩ LED(CAPACITY)	⑪ Battery Positive	⑫ Battery ON/OFF
⑬ Battery Negative			

3.5 Working Mode of Loads

The power module has two load working modes: mains priority mode and battery priority mode, which are applicable to different power consumption environments. By default, the mains priority mode is set before delivery.

Mains priority mode: When the mains is normal, the loads are powered by mains preferentially. When the mains is unavailable, the battery is used to supply power and this will be adopted in the areas with unstable power grids.

Battery priority mode: During normal operation, the loads are preferentially powered by battery. When the battery voltage is low, the mains will be switched to supply power. This model maximizes the utilization of photovoltaic and battery power and can be used in areas where the grid is stable but electricity prices are relatively expensive.

4 Application Scenarios and Settings

4.1 Application Scenarios

4.1.1 Application Scenarios with Only Mains Power but No Photovoltaic

When the mains is normal, it charges the battery and supplies power to the loads.

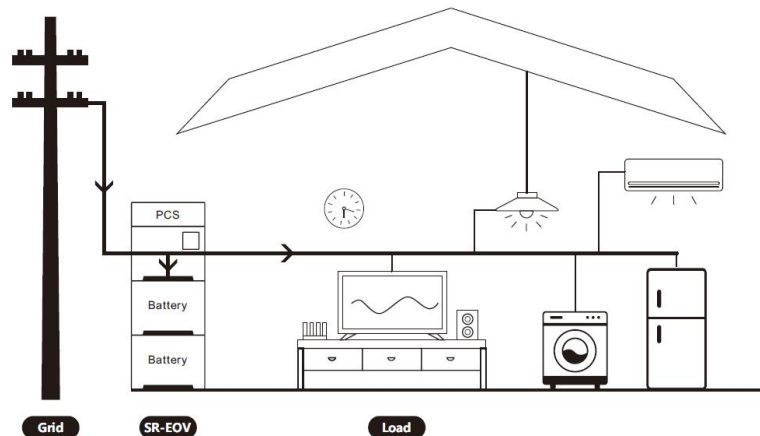

When the mains is disconnected or stops working, the battery supplies power to the load through the power module.

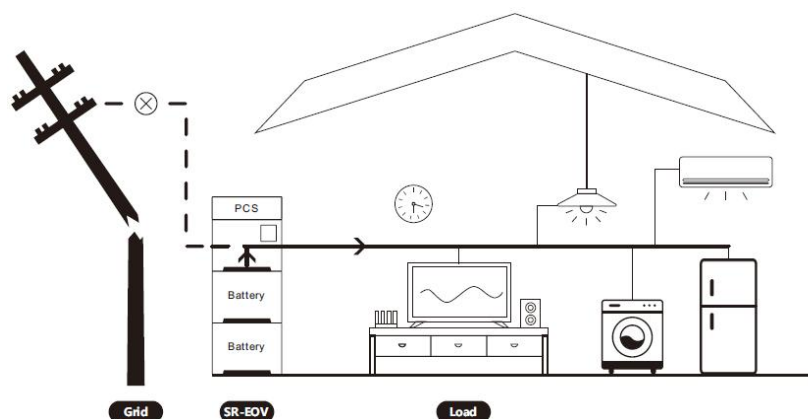

4.1.2 Application Scenarios with Only Photovoltaic but No Mains Power

During the day, the photovoltaic directly supplies power to the loads while charging the battery.

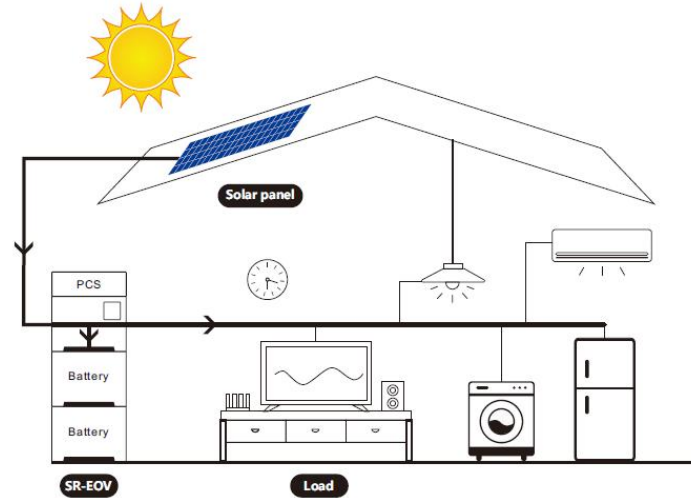

At night, the battery supplies power to the loads through the power module.

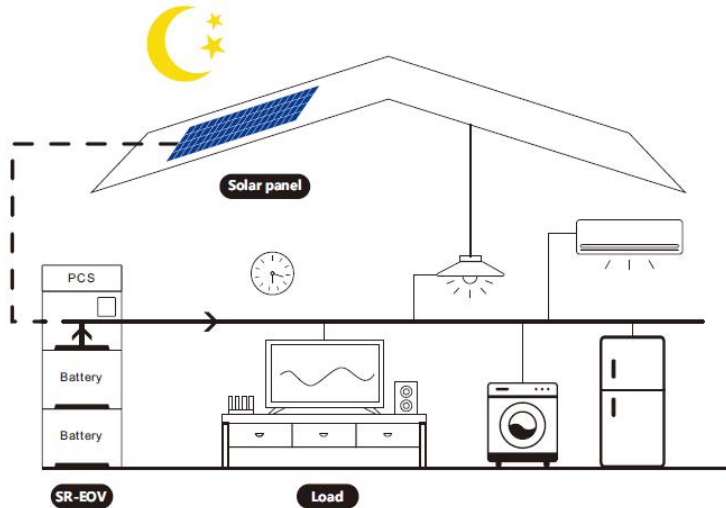

4.1.3 Complete Application Scenarios

During the day, the mains and photovoltaic simultaneously charge the battery and supply power to the loads.

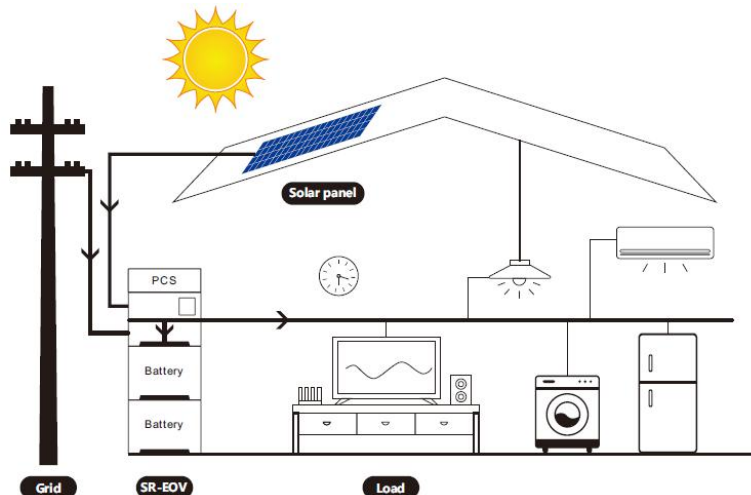

At night, the mains supplies power to the loads, and continues to charge the battery, if the battery is not fully charged.

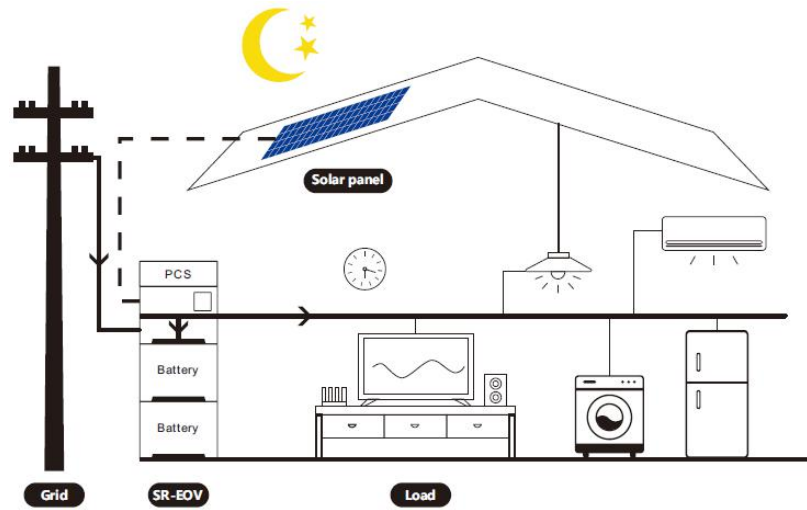

If the mains is disconnected, the battery supplies power to the loads.

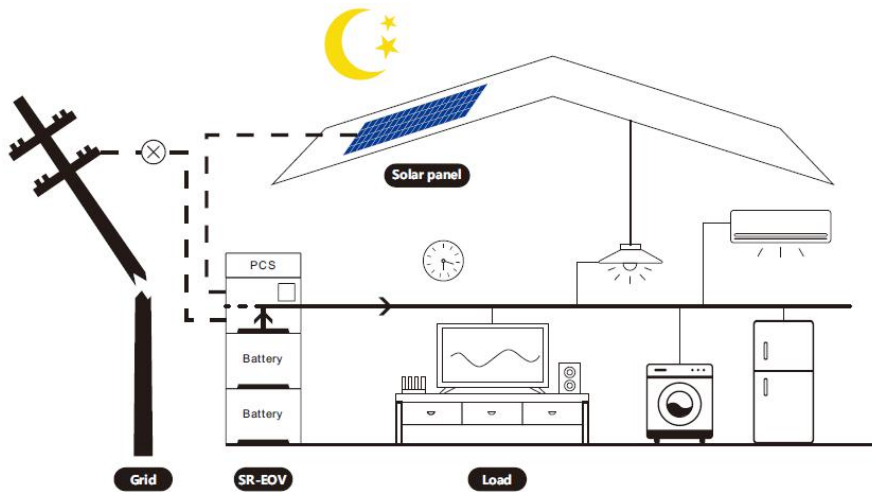

4.2 Load Working Mode

Load working mode	PCS setting	Description
PV priority mode	SOL	switching to the Mains when the PV fails or the battery is lower than the set value of parameter
Mains priority mode	UTI	Mains priority mode, switching to inverter only when the mains fails.
Inverter priority mode	SBU	switching to the mains only when the battery is under voltage or lower than the set value of parameter

5 System Installation

5.1 Inspections before Installation









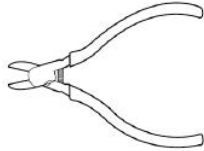
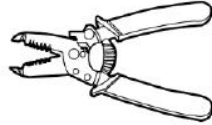

Inspection of outer package

Before opening outer package of the energy storage, check if there is any visible damage on the outer package, such as holes, cracks or other signs of possible internal damage, and check the type of energy storage. If there is any abnormality on the package or model of the energy storage is inconsistent, do not open it and contact us as soon as possible.

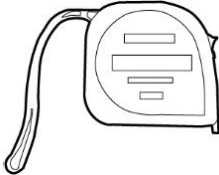
Inspection of deliverables

After opening outer package of the energy storage, check if the deliverable is complete and whether there is any visible external damage. If any items are missing or damaged, please contact us.

5.2 Preparation of Tools and Meters

Types	Tools and meters		
Installation tool			  ①  ②
			
Personal protective equipment			
			

5.3 Selection of Installation Location

5.3.1 Basic Requirements

- When the energy storage is running, the temperature of the case and the radiator will be high. Therefore, do not install them in a place that is easy to touch.
- Do not install in areas where flammable and explosive materials are stored.

- If the energy storage is installed in areas with salt damage, it will be corroded and may cause fire. Therefore, do not install it outdoors in areas with salt damage. The areas with salt damage are defined as the areas which are not 500m away from shore or will be affected by sea breezes. The areas affected by the sea breezes vary depending on meteorological conditions (e.g. typhoons, monsoons) or topographical conditions (dams, hills).
- Do not install in the place where children can touch.
- The energy storage cannot be installed forwardly, horizontally, inversely, backwardly or sideways.
- When drilling holes on walls or ground, the goggles and protective gloves shall be worn.
- During drilling, the device should be shielded to prevent debris from falling into the device. After drilling, the debris shall be cleaned up in time.
- When handling any heavy objects, you should be prepared to bear loads to avoid being crushed or sprained.
- When handling the device by hand, wear protective gloves to avoid injury.

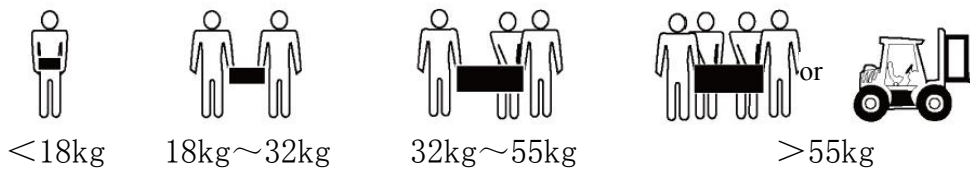

5.3.2 Installation Space Requirements

When installing the energy storage, certain space shall be left around it to ensure sufficient space for installation and heat dissipation.

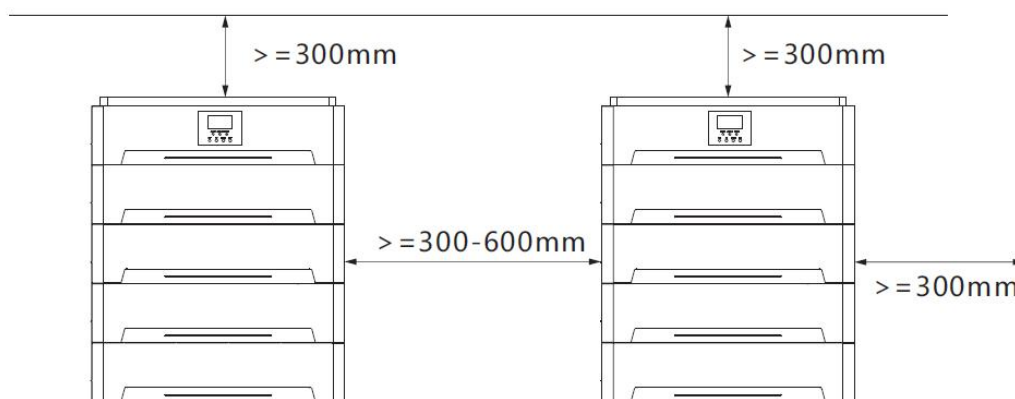

5.4 Device Installation

The battery should be placed in the right position first, and the installation site should be smooth and the floor should be solid, and the device is 30-50cm away from the wall.

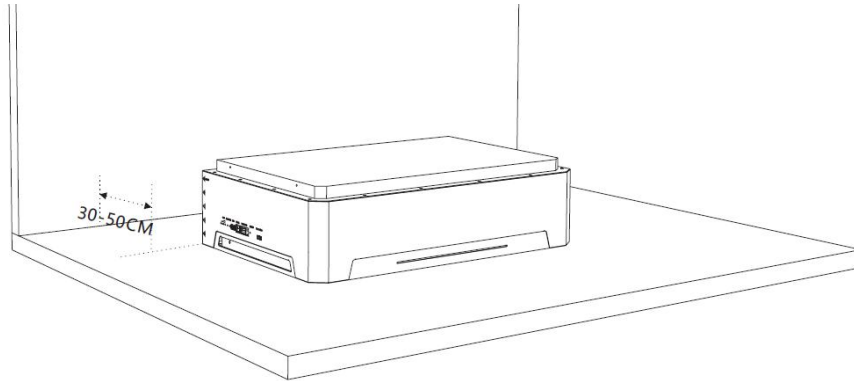

If there is more than one battery, the first battery should be placed properly before placing other batteries.

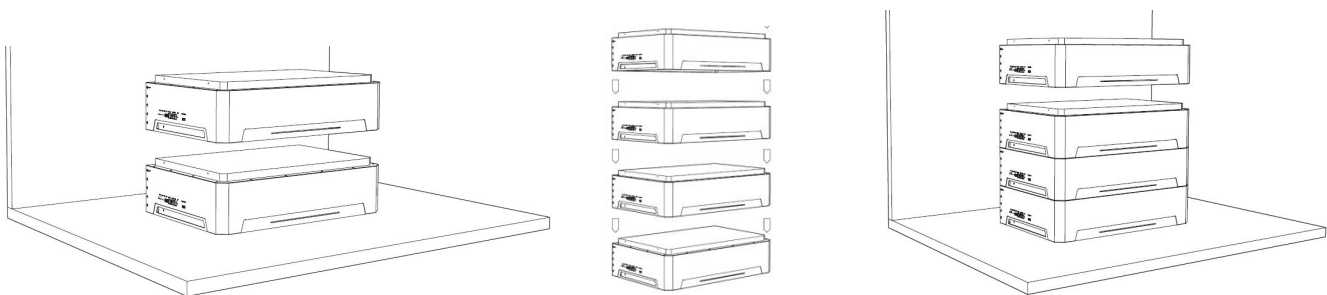

Installers should pay attention to the direction during installation. They shall be installed vertically and shall not be tilted.

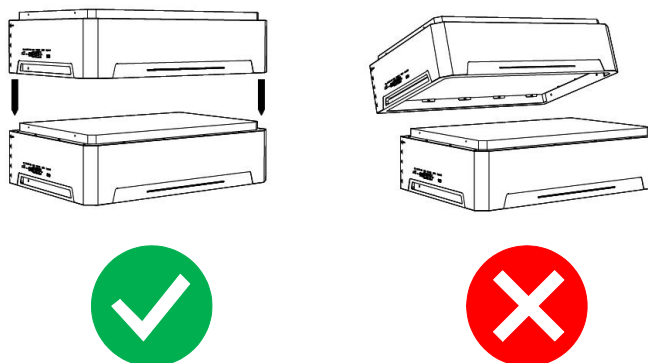

Install the PCS module, The PCS module should be installed at the top, not in other positions.

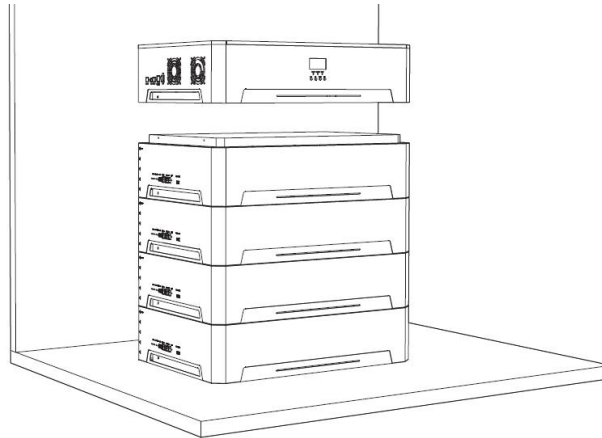

6 Electrical Connection





Before electrical connection, please ensure that the switches of the energy storage and power module and all switches connected to the energy storage are in the "OFF" state, and the power module is in the OFF state. Otherwise, the high voltage of the device may

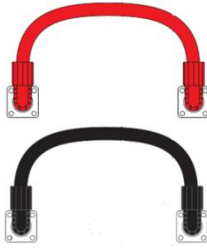

- The device damage caused by incorrect wiring is not covered in warranty scope of the device.
- The operations related to electrical connections must be carried out by professional electrical technicians.
- When carrying out electrical connections, the operator must wear personal protective articles.

6.1 Preparation of Cables

No.	Cables	Description	Recommended specifications	Source
1	Photovoltaic input line	Cable between the photovoltaic panel and power module	Cable diameter 6mm ² /10AWG	Prepare by the user itself
2	AC input line	Cable between AC input and power module	Cable diameter 10mm ² /7AWG	Prepare by the user itself
3	AC output line	Cable between AC output and power module	Cable diameter 10mm ² /7AWG	Prepare by the user itself
4	Parallel connection cable of energy storage	Power cable between the storage battery modules		Provide with the product together
5	Signal line of energy storage	Signal cable between the storage battery modules		Provide with the product together
6	Ground wire	Ground cable between the storage battery modules		Provide with the product together

6.2 Internal Electrical Connection of Energy Storage

6.2.1 Connecting Grounding Wire

Each energy storage battery module shall be connected with the grounding wire provided with the product together.

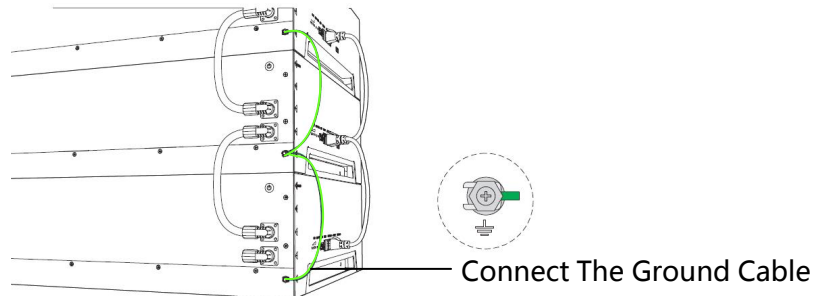

6.2.2 Connecting Power Cord

Before connecting the energy storage battery module, ensure that the energy storage battery is not working and the indicator lights on the battery are OFF. The power cord delivered with the product together should be used to connect the positive and negative terminals of other batteries or power modules. It shall be noticed that the red cable should be connected to the red terminal (positive battery terminal) and the black cable to the black terminal (negative battery terminal).

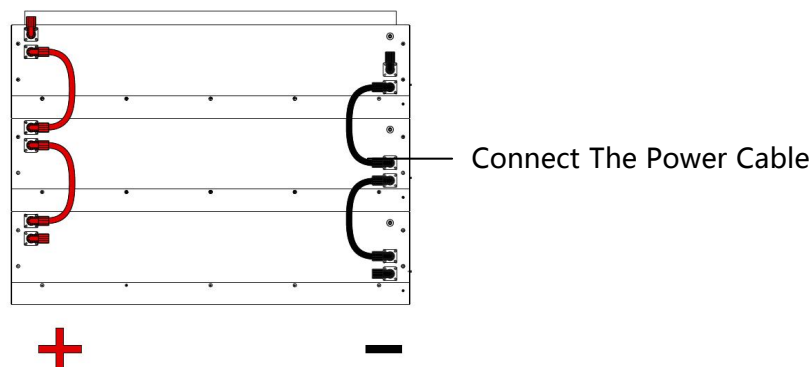

6.2.3 Connecting Signal Line

The signal line delivered with the product together shall be used to connect RS485 interface for each battery module.

The communication port of the inverter needs to be connected to the RS485-2 interface.

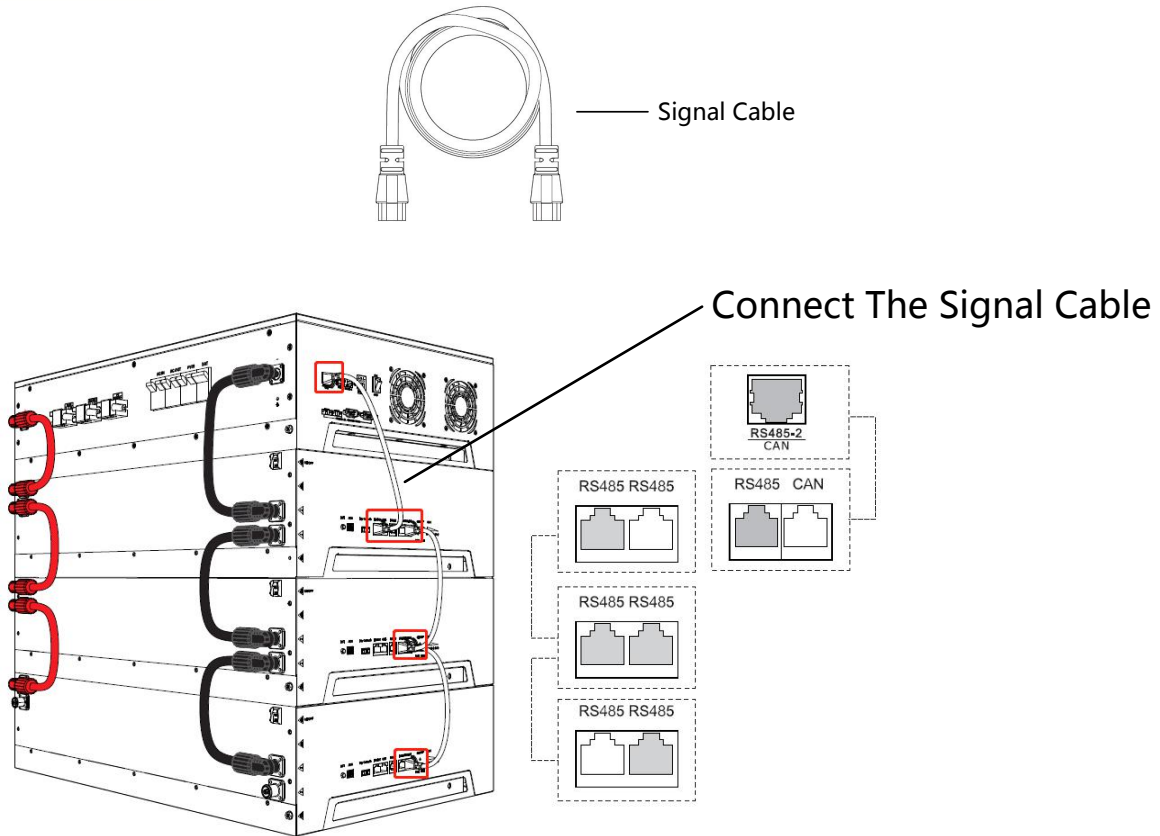

6.2.4 Energy Storage Battery Module Address Setting

If multiple energy storage battery modules are used in parallel, the address of the energy storage battery module needs to be set. The address is set to 1~4, and the address of each module cannot be repeated.

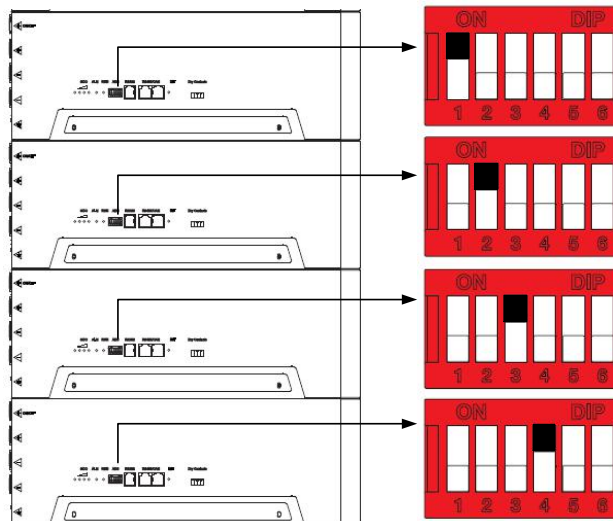

6.3 External Electrical Connection of Energy Storage

6.3.1 Connecting AC Input

According to the cable sequence and terminal position shown in the figure below, correctly connect the AC input line. Please pay attention to L and N and avoid short-circuit when wiring.

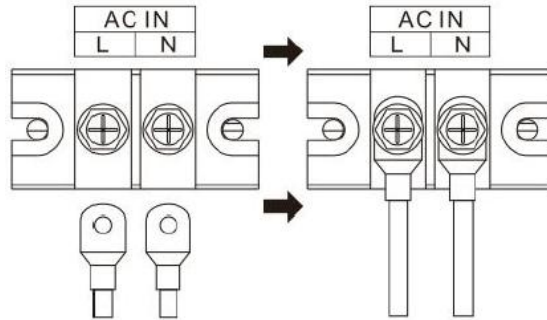

6.3.2 Connecting AC Output

According to the cable sequence and terminal position shown in the figure below, correctly connect the AC output cable. When wiring, please pay attention to L and N and avoid short-circuit.

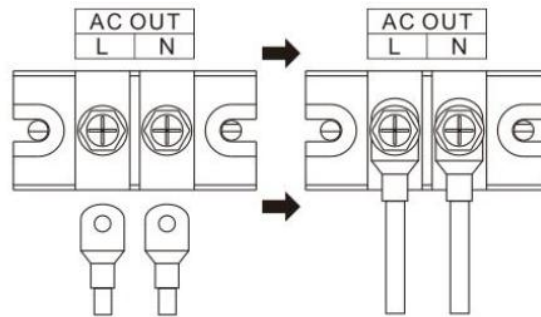

6.3.3 Connecting Photovoltaic Input

According to the cable sequence and terminal position shown in the figure below, correctly connect the PV input cable. When wiring, please pay attention to the positive and negative poles and avoid short-circuit.

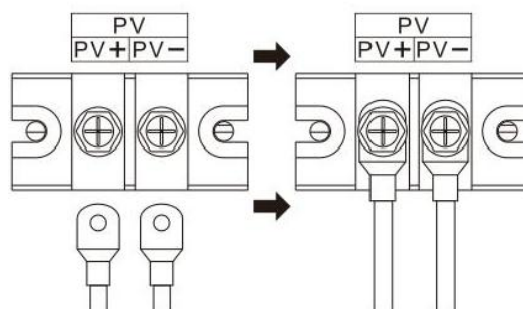

6.3.4 Wiring specifications

Models	Recommended PV wiring diameter	Recommended AC input wiring diameter	Recommended AC output wiring diameter
SR-EOH48-5.0S-	6mm ² /10AWG	10mm ² /7AWG	10mm ² /7AWG
SR-EOH48-5.0U-	6mm ² /10AWG	10mm ² /7AWG	10mm ² /7AWG

7 System Debugging

7.1 Inspections before Power-On

No.	Inspection items	Acceptance criteria	Validation
1	The energy storage is installed in place	The installation is correct, secure and reliable.	<input type="checkbox"/> Yes <input type="checkbox"/> No
2	The installation environment meets requirements	The installation space is reasonable and the environment is clean and tidy without any construction remains.	<input type="checkbox"/> Yes <input type="checkbox"/> No
3	The energy storage power cord is correctly connected	The positive and negative terminals are connected correctly without any missing.	<input type="checkbox"/> Yes <input type="checkbox"/> No
4	The energy storage signal line is correctly connected	The signal line is connected reliably	<input type="checkbox"/> Yes <input type="checkbox"/> No
5	The grounding is reliable	The grounding wire is correctly and reliably connected.	<input type="checkbox"/> Yes <input type="checkbox"/> No
6	The switch of the energy storage battery module is off	All switches connected to the energy storage are in the "OFF" state.	<input type="checkbox"/> Yes <input type="checkbox"/> No
7	All air switches of the power module are off	All air switches of the power module are in the "OFF" state.	<input type="checkbox"/> Yes <input type="checkbox"/> No

7.2 Power-On of Power Module

7.2.1 PCS Breaker Sequence

First, Turn on the battery input breaker switch; then turn on the PV, AC output and AC input breaker switch.

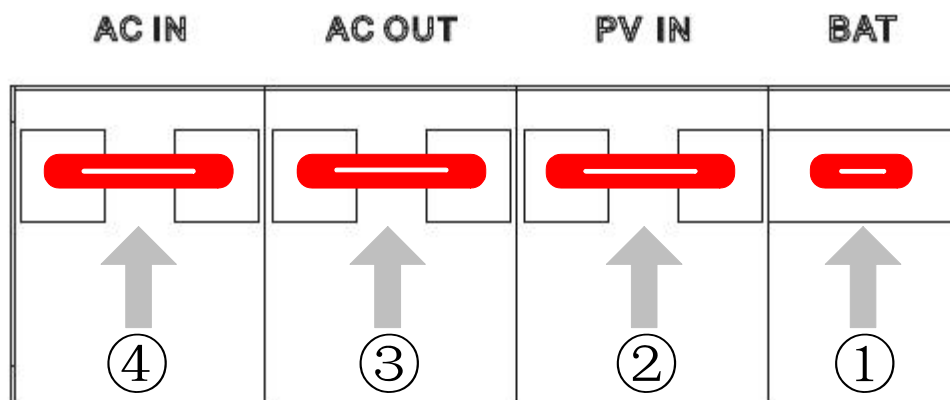

7.2.2 Power-On of Energy Storage Battery Module

After turn on the battery input breaker switch and confirmation, turn on the switch of the energy storage battery module. If there are multiple modules, please turn on the power switch one by one according to the address sequence.

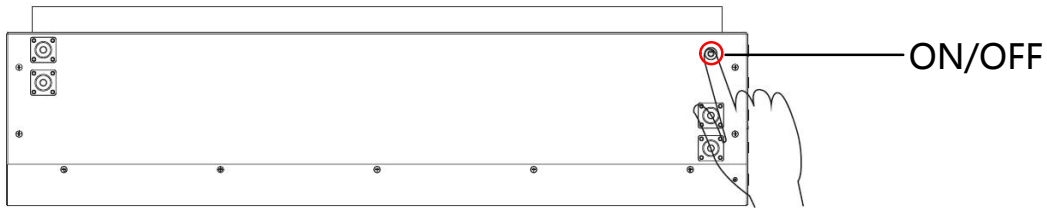

After the power switch is turned on, the LED indicator will light up or flash. The meaning of the LED indicator is as follows.

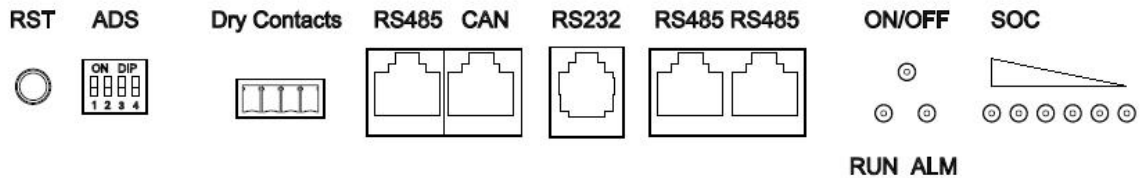

System Status	Events	ON/OFF	RUN	ALM
POWER OFF	Power Off	OFF	OFF	OFF
Steady	Normal	ON	Blinking1	OFF
	Alarm	ON	Blinking1	Blinking3
Charging	Normal	ON	ON	OFF
	Alarm	ON	ON	Blinking3
	Over Charge Protection	ON	ON	OFF
	High temperature, Over Current	ON	OFF	ON
Discharging	Normal	ON	Blinking3	OFF
	Alarm	ON	Blinking3	Blinking3
	Over Discharge Protection	ON	OFF	OFF
	Over Current , Short Current	ON	OFF	ON

LED blinking description

Blinking	LED ON	LED OFF
Blinking1	0.25S	3.75S
Blinking2	0.5S	0.5S
Blinking3	0.5S	1.5S

7.2.3 Power-On of PCS

After all loads are connected, . turn the rocker switch on the left side of the machine to the "ON"state. The "AC/INV" indicator flashing indicates that the inverter is working normally.

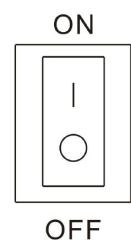

7.2.4 PCS LED And Button Function Description

After the power module works normally, the indicator lights are described as follows:

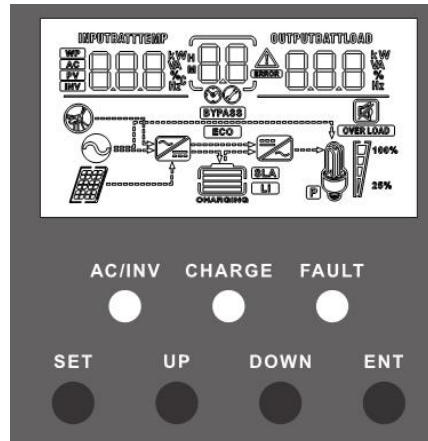

Indicators introduction

Indicator lights	Color	State	Description
AC/INV	Yellow	Always ON	Mains output
		Blinking	Inverter output
CHARGE	Green	Blinking	The battery is being charged
		Always ON	Charging is completed
FAULT	Red	Always ON	Fault state

Operation buttons introduction

Function buttons	Description
SET	Enter/Exit Settings menu
UP	Previous choice
DOWN	Next choice
ENT	Confirm/Enter Options under the settings menu





7.2.5 PCS Real-time Data Viewing Method





On the LCD main screen, press the “UP” and “DOWN” buttons to scroll through the real-time data of the machine.







NO.	Parameters on the left side of the screen		Parameters on the right side of the screen	
	LCD Screen	Introduction	LCD Screen	Introduction
1	INPUT BATT V	Battery input voltage	OUTPUT LOAD V	Output load voltage
2	PV TEMP °C	PV charger heatsink temperature	PV OUTPUT KW	PV output power
3	PV INPUT V	PV input voltage	PV OUTPUT A	PV output current
4	INPUT BATT A	Input battery current	OUTPUT BATT A	Battery output current
5	INPUT BATT KW	Battery input power	OUTPUT BATT KW	Battery output power
6	AC INPUT Hz	AC input frequency	AC OUTPUT LOAD Hz	AC output frequency
7	AC INPUT V	AC input voltage	AC OUTPUT LOAD A	AC output load current
8	INPUT V	For maintain	OUTPUT LOAD KVA	Load apparent power
9	INV TEMP °C	AC charge or battery discharge heatsink temperature	INV OUTPUT LOAD KW	Load active power
10	888	APP software version	888	Bootloader software version
11	888	Model Battery Voltage Rating	888	Model Output Power Rating
12	888	Model PV Voltage Rating	888	Model PV Current Rating







7.2.6 PCS parameter adjustment







NO.	Parameter name	allow adjustment	Settings (default)	Description
[00]	Exit setting menu		ESC	Exit the setup menu
[01]	Work priority mode		SOL	PV priority mode, switching to the Mains when the PV fails or the battery is lower than the set value of parameter [04].
			UTI	Mains priority mode, switching to inverter only when the mains fails.
			SBU	Inverter priority mode, switching to the mains only when the battery is under voltage or lower than the set value of parameter [04].





NO.	Parameter name	allow adjustment	Settings (default)	Description
[02]	Output Frequency		50.0	Bypass self-adaptation; when the mains is connected, it automatically adapts to the mains frequency; when the mains is disconnected, the output frequency can be set through this menu. The default output frequency of the 230V machine is 50HZ, and the 120V machine 60HZ.
			60.0	
[03]	AC Input Voltage Range		APL	Wide mains input voltage range of 230V machine: 90~280V Mains input voltage range of 120V machine: 90~140V
			UPS	Narrow mains input voltage range of 230V machine: 170~280V Mains input voltage range of 120V machine: 90~140V
[04]	Battery Power to Utility Setpoint		48.0V	When the parameter [01] =SOL/SBU, the battery voltage is lower than the set value, and the output is switched from the inverter to the mains. Setting range: 44V~52V.
[05]	Utility to Battery Power Setpoint		52.8V	When the parameter [01] =SOL/SBU, the battery voltage is higher than the set value, and the output is switched from the mains to the inverter. Setting range: 48V~60V.
[06]	Charger source priority		CSO	PV priority charging; only when the PV charging fails, the mains charging is started.
			CUB	Mains priority charging; only when the mains charging fails, the PV charging is started.
			SNU	PV and Mains hybrid charging; PV charging is a priority, and when the PV energy is insufficient, the Mains

NO.	Parameter name	allow adjustment	Settings (default)	Description
				charging supplements. When the PV energy is sufficient, the Mains charging stops. Note: Only when the Mains bypass output is loaded, the PV charging and the mains charging can work at the same time. When the inverter works, only the PV charging can be started.
			OSO	Only PV charging, with the Mains charging not activated.
[07]	Max charger current		60A	230V Max charger current (AC charger+PV charger). Setting range: 0~140A ; 120V Max charger current (AC charger+PV charger). Setting range: 0~120A ;
[08]	Battery Type		LF14 LF15 LF16 N13 N14	14 strings LiFePO ₄ battery 15 strings LiFePO ₄ battery 16 strings LiFePO ₄ battery 13 strings NCM battery 14 strings NCM battery
[09]	Battery boost charge voltage		56.8V	Boost charge voltage setting; the setting range is 48V~58.4V, with step of 0.4V; it is valid for user-defined battery and lithium battery.
[10]	Battery boost charge time		120	Boost charge maximum time setting, which means the maximum charging time to reach the set voltage of parameter [09] during constant-voltage charging. The setting range is 5min~900min, with a step of 5 minutes. It is valid for user-defined battery and lithium battery.

NO.	Parameter name	allow adjustment	Settings (default)	Description
[11]	Battery floating charge voltage		56.8V	Floating charge voltage, setting range: 48V~58.4V, step: 0.4V, valid when battery type is user-defined.
[12]	Battery over discharge voltage (delay off)		46.8V	Over-discharge voltage; when the battery voltage is lower than this judgment point, delay the time set by parameter [13] and turn off inverter output. Setting range is 40V~48V, with a step of 0.4V. It is valid for user-defined battery and lithium battery.
[13]	Battery over discharge delay time		5S	Over-discharge delay time; when the battery voltage is lower than the parameter [12], the inverter output will be turned off after the time set by this parameter is delayed. The setting range is 5S~55S, with a step of 5S. It is valid for user-defined battery and lithium battery.
[14]	Battery under voltage alarm		49.6V	Battery undervoltage alarm point; when the battery voltage is lower than the point, an undervoltage alarm is given, and the output is not turned off; the setting range is 40V~52V, with a step of 0.4V. It is valid for user-defined battery and lithium battery.
[15]	Battery discharge limit voltage		46.4V	Battery discharge limit voltage; when the battery voltage is lower than the point, the output is turned off immediately; the setting range is 40V~52V, with a step of 0.4V. It is valid for user-defined battery and lithium battery.
[16]	Battery equalization enable		DIS	Equalizing charge is disabled
			ENA	Equalizing charge is enabled, only valid for vented lead-acid battery and

NO.	Parameter name	allow adjustment	Settings (default)	Description
				sealed lead-acid battery
[17]	Battery equalization voltage		58.4V	Equalizing charge voltage; setting range: 48V~58.4V, with a step of 0.4V; valid for vented lead-acid battery and sealed lead-acid battery
[18]	Battery equalized time		120	Equalizing charge time; setting range: 5min~900min, with a step of 5 minutes; valid for vented lead-acid battery and sealed lead-acid battery
[19]	Battery equalized time out		120	Equalizing charge delay; setting range: 5min~900min, with a step of 5 minutes; valid for vented lead-acid battery and sealed lead-acid battery
[20]	Battery equalization interval		30	Equalizing charge derating time, 0~30days, with a step of 1 day; valid for vented lead-acid battery and sealed lead-acid battery
[21]	Battery equalization immediately		DIS	Stop equalizing charge immediately.
			ENA	Start equalizing charge immediately.
[22]	Power saving mode		DIS	Power saving mode disabled.
			ENA	After the power saving mode is enabled, if the load is null or less than 50W, the inverter output is turned off after a delay for a certain period of time. When the load is more than 50W, the inverter automatic restart.
[23]	Restart when over load		DIS	Automatic restart when overload is disabled. If an overload occurs and the output is turned off, the machine will not restart.
			ENA	Automatic restart when overload is enabled. If an overload occurs and

NO.	Parameter name	allow adjustment	Settings (default)	Description
				the output is turned off, the machine will restart after a delay of 3 minutes. After it reaches 5 cumulative times, the machine will not restart.
[24]	Restart when over temperature		[24] DIS	Automatic restart when over temperature is disabled. If an over-temperature shutdown occurs, machine will not restart to turn the output on.
			ENA	Automatic restart when over temperature is enabled. If an over-temperature shutdown occurs, the machine will restart when the temperature drops.
[25]	Alarm enable		DIS	Alarm is disabled
			ENA	Alarm is enabled
[26]	Beeps while primary source is interrupted		DIS	Alarm beep is disabled when the status of the main input source changes
			ENA	Alarm beep is enabled when the status of the main input source changes
[27]	Bypass output when over load		DIS	It is disabled to automatically switch to the Mains when the inverter is overloaded.
			ENA	It is enabled to automatically switch to the Mains when the inverter is overloaded.
[28]	Max AC charger current		60A	AC Out 230Vac Setting range 0~60A
			40A	AC Out 120Vac Setting range 0~40A
[30]	RS485 Address setting		1	RS485 communication address setting range 1 ~ 254
[32]	RS485-1 communication		485	RS485-2 port for BMS communication.

NO.	Parameter name	allow adjustment	Settings (default)	Description
[33]	Battery BMS communication protocol		PYL	you can choose to match the battery manufacturer's BMS protocol to communicate with BMS for the lithium battery protection.
[35]	Battery overdischarge recovery point		52V	When the battery voltage is overdischarge voltage, the battery voltage needs to recover more than this set value before the inverter starts the output
[37]	Battery fully charged recovery point		52V	After the battery is fully charged, it needs to be lower than this set voltage before it can be recharged
[38]	AC output voltage setting		220V	Settable : (200/208/220/240Vac)
			110V	Settable : (100/105/110Vac)

8 System Maintenance

8.1 System Power-Off



- After the system is powered off, the case still has residual power and heat, which may cause electric shocks or burns. Therefore, protective gloves should be worn before operating the energy storage 5 minutes after the system is powered off. Maintenance operations on energy storage should be performed only after ensuring that all indicator lights of the energy storage are off.
- When the energy storage system is running, the system cannot be powered off completely when only turning off the switch of the power unit. At this time, no maintenance operation can be performed on the energy storage. The switch of energy storage must be turned off before maintenance operation can be performed.

Power-off operation steps of the system:

Step 1 Turn off the switch between the power unit and AC output.

Step 2 Turn off the switch between the power unit and AC input.

Step 3 Turn off the switch between the power unit and the PV string.

Step 4 Turn off the switch between the power unit and the energy storage battery unit.

Step 5 Turn off switches on all energy storage units and hold down the key on energy storage for three seconds until all indicator lights turn off and the energy storage is powered off successfully.

8.2 Routine Maintenance

To ensure the long-term and good operation of the energy storage system, it is recommended to perform the routine maintenance as described in this section.

Items	Methods	Maintenance interval
System cleanliness	Check if the radiator is covered or dirt on a regular basis.	Once every six months to one year.
Running status of system	<ul style="list-style-type: none"> • Observe whether the energy storage appearance is damaged or deformed. • Listen to whether the energy storage has any abnormal sound during running. • When the energy storage is running, check whether the energy storage parameters are set correctly. 	Once every six months.
Electrical connection	<ul style="list-style-type: none"> • Check if any cable connection is off or loose. • Check if any cable is damaged, and especially if there are cuts on the sheath where the cable contacts with the metal surface. • Check if the unused DC input terminals, energy storage terminals, COM ports, and waterproof covers are locked. 	Half a year after first debugging and testing, and once every six months to one year thereafter.
Grounding reliability	Check if the grounding cable is grounded reliably.	Half a year after first debugging and testing, and once every six months to one year thereafter.

8.3 Troubleshooting

8.3.1 Fault Code and Handling Methods

Fault code	Fault name	Whether it affects the output or not	Description
【01】	BatVoltLow	No	Battery undervoltage alarm
【02】	BatOverCurrSw	Yes	Battery discharge average current overcurrent software protection
【03】	BatOpen	Yes	Battery not-connected alarm
【04】	BatLowEod	Yes	Battery undervoltage stop discharge alarm
【05】	BatOverCurrHw	Yes	Battery overcurrent hardware protection
【06】	BatOverVolt	Yes	Charging overvoltage protection
【07】	BusOverVoltHw	Yes	Bus overvoltage hardware protection
【08】	BusOverVoltSw	Yes	Bus overvoltage software protection
【09】	PvVoltHigh	No	PV overvoltage protection
【10】	PvBuckOCSw	No	Buck overcurrent software protection
【11】	PvBuckOCHw	No	Buck overcurrent hardware protection
【12】	bLineLoss	No	Mains power down

【13】	OverloadBypass	Yes	Bypass overload protection
【14】	OverloadInverter	Yes	Inverter overload protection
【15】	AcOverCurrHw	Yes	Inverter overcurrent hardware protection
【17】	InvShort	Yes	Inverter short circuit protection
【19】	OverTemperMppt	No	Buck heat sink over temperature protection
【20】	OverTemperInv	Yes	Inverter heat sink over temperature protection
【21】	FanFail	Yes	Fan failure
【22】	EEPROM	Yes	Memory failure
【23】	ModelNumErr	Yes	Model setting error
【26】	RlyShort	Yes	Inverted AC Output Backfills to Bypass AC Input
【29】	BusVoltLow	Yes	Internal battery boost circuit failure
【30】	BatSocLow1	No	Battery Soc < 10%
【31】	BatSocLow2	No	Battery Soc < 5%
【32】	BatSocLowStop	Yes	Battery Soc < 1%, Turn off the inverter
【60】	BmsBatTempLow	No	Battery low temperature warning
【61】	BmsBatTempHigh	No	Battery high temperature warning
【62】	BmsBatOverCurr	No	Battery over current warning
【63】	BmsBatVoltLow	No	Battery low voltage warning
【64】	BmsBatOverVolt	No	Battery over voltage warning

8.3.2 Common Faults and Handling Methods

Faults	Handling measures
No display on the screen	Check if the battery air switch or the PV air switch has been closed; if the switch is in the "ON" state; press any button on the screen to exit the screen sleep mode.
Battery overvoltage protection	Measure if the battery voltage exceeds rated, and turn off the PV array air switch and Mains air switch.
Battery undervoltage protection	Charge the battery until it returns to the low voltage disconnection recovery voltage.
Fan failure	Check if the fan is not turning or blocked by foreign object.
Heat sink over temperature protection	When the temperature of the device is lower than the recovery temperature, normal charge and discharge control is resumed.
Bypass overload protection, inverter overload protection	① Reduce the use of power equipment; ② Restart the unit to resume load output.

Inverter short circuit protection	① Check the load connection carefully and clear the short-circuit fault points; ② Re-power up to resume load output.
PV overvoltage	Use a multimeter to check if the PV input voltage exceeds the maximum allowable input voltage rated.
Battery missed alarm	Check if the battery is not connected or if the battery circuit breaker is not closed.

8.4 Battery Storage and Maintenance

8.4.1 Battery Storage Requirements



Do not put the battery into fire. The battery may explode.

Do not open or damage the battery. The electrolyte flowing out from the battery is harmful to the skin and eyes. The electrolyte may also be toxic;

1. When being stored, the batteries shall be placed correctly in accordance with the marks on the packing case. Do not put them upside down or on the side.
2. When stacking up the battery packing cases, the stacking requirements on the outer package shall be met.
3. The batteries should be handled with care, and damage to batteries should be strictly prohibited.
4. Requirements for the storage environment:
 - Ambient temperature: -10°C to 55°C , recommended storage temperature: 20°C to 30°C .
 - Relative humidity: 5%RH-80%RH.
 - Dry, well ventilated, and clean.
 - The corrosive organic solvents, gases and other substances shall be kept away.
 - Exposing to direct sunlight shall be avoided.
 - The distance from the heat source should not be less than two meters.
5. When being stored, the battery shall be disconnected from the external connection. If there is an indicator light on the battery panel, the indicator light shall be off.
7. The warehouse keeper shall make monthly statistics on the battery storage, and regularly inform the planning link of the battery inventory. If any battery has been stored for nearly 15 months (-10°C to 25°C), 9 months (25°C to 35°C), or 6 months (35°C to 55°C), recharging shall be arranged in time.
8. When the stored batteries are going to be delivered, the first-in first-out principle should be followed.
9. After the battery is produced and tested, it shall be recharged to at least 50% SOC before being stored. If the device will not be used for a long period of time, discharge the battery to 45% to 60% of the battery capacity and disconnect the battery output to avoid the battery runs out;
10. Do not touch the battery pack with wet hands.
11. Do not squeeze, drop, or pierce the battery.

12. The battery should always be disposed in accordance with local safety regulations.
13. The battery should be stored and recharged in accordance with this User's Manual.
14. Do not reverse polarity of the battery when storing or transporting the batteries, the batteries shall not be stacked up without protective packaging, and the number of stacked packed batteries should not exceed the number specified on the packaging.
15. All operators of the energy storage system shall comply with the user manual, installation and service manual, and quality assurance requirements. Any damage to the device resulting from neglecting or misreading of the user's manual, installation and service manual, and the quality assurance requirements will invalidate the product warranty.

8.4.2 Requirements for Charging of Battery

The batteries to be stored for a long period of time (unused, for more than 3 months) must be kept in a dry and cool place. The storage voltage is 51V-53V. The batteries should be stored in a clean environment of $23 \pm 2^{\circ}\text{C}$ and humidity of 45%-75%. If the battery will be shelved and not used for a long period of time, it should be recharged every 3 months to ensure that the battery voltage is within the above range.

As for batteries and long-term storage, routine maintenance is required. Please charge the battery to 40% SOC at a current of 0.2C according to the requirements in the table below.

Ambient temperature for storage	Relative humidity for storage environment	Storage Time	SOC
<-10°C	/	Prohibited	/
-10~25°C	5%~70%	≤12 months	30%≤SOC≤60%
25~35°C		≤6 months	
35~45°C		≤3 months	
>45°C	/	Prohibited	/

8.5 Device Cleaning

It is recommended to clean and maintain the product from time to time. When cleaning, the dust and stains on the product shall be removed with a piece of soft dry cloth or vacuum cleaner, especially when cleaning the heat dissipation and air vents on both sides of the product. The product shall not be cleaned with organic solvents, corrosive liquids and other cleaning products.

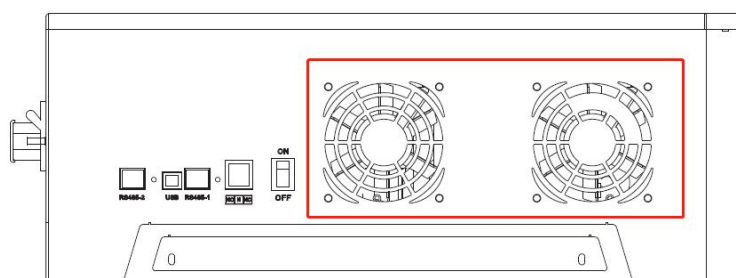

9 Technical Data

9.1 Power Module Data

		SR-EOH48-5.0S-C0	SR-EOH48-5.0U-C0
Battery Inverter	Rated Output Power	5KW	5KW
	Maximum Peak Power	10KVA	10KVA
	Power Factor	1	1
	Rated Output Voltage (Vac)	230Vac	120Vac
	Frequency	50Hz	60Hz
	Auto Switch Period	< 15ms	< 15ms
	THD	< 3%	< 3%
AC Charge	Maximum AC Charge Power	3150W	2100W
	AC Charging Current Range	0 ~ 60A	0 ~ 40A
	Rated Input Voltage	220/230Vac	110/120Vac
	Input Voltage Range	90 ~ 280Vac	90 ~ 140Vac
AC Output	Rated Output Power	5KW	5KW
	Maximum Output Current	30A	50A
	Frequency	50Hz	60Hz
	Overload Current	35A	55A
PV Charge	Solar Charge Type	MPPT	MPPT
	Maximum Output Power	5KW	5KW
	PV Charging Current Range	0 ~ 80A	0 ~ 80A
	PV Operating Voltage Range	120 ~ 500V	120 ~ 500V
	MPPT Voltage Range	120 ~ 450V	120 ~ 450V
General Data	Operating Temperature Range	-15°C ~ 55°C	-15°C ~ 55°C
	Storage Temperature Range	-25°C ~ 60°C	-25°C ~ 60°C
	Humidity Range	5% to 95%	5% to 95%
	Nominal Operation Altitude	< 2000m	< 2000m
	Cooling Mode	Force-Air Cooling	Force-Air Cooling
	Noise	60dB(A)	60dB(A)
	Ingress Protection Rating	IP20	IP20
	Certification	CE(EN62109-1)	CE(EN62109-1)
	EMC Certification Level	EN61000, C2	EN61000, C2
	Gross Weight	27Kg	27Kg
	Dimension L× D× H	710×450×192	710×450×192

9.2 Battery Module Data

Battery Type	LiFePO4
Battery Energy	5.12kWh
Battery Capacity	100AH
Battery Rated Voltage	51.2V
Battery Working Voltage Range	44.8 ~ 57.6V
Maximum Charging Current	100A
Maximum Discharging Current	100A
DOD	80%
Parallel Quantity	4
Designed Life-span	6000
Operating Temperature	Charge : 0 ~ 45°C Discharge : -10 ~ 45°C
Operation Humidity	5% ~ 85%
Nominal Operation Altitude	< 3000m
Ingress Protection Rating	IP20
Recommended Operation Environment	Indoor
Installation Method	Horizontal
Gross Weight	53kg
Dimension L× D× H	710×450×192

10 Product Dimensions and Packaging

10.1 Product Dimensions

The external dimensions of the energy storage battery module and power module are 710*450*192.

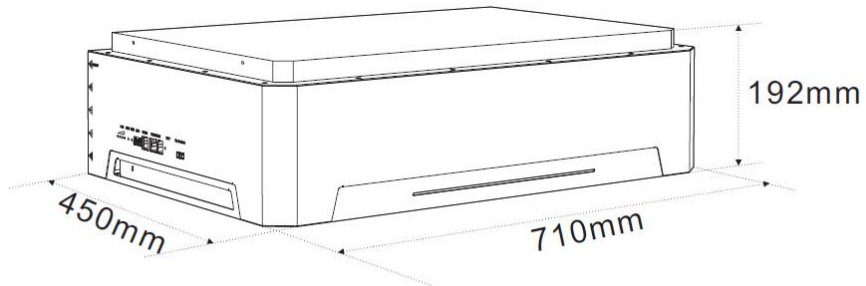

10.2 Package Dimensions



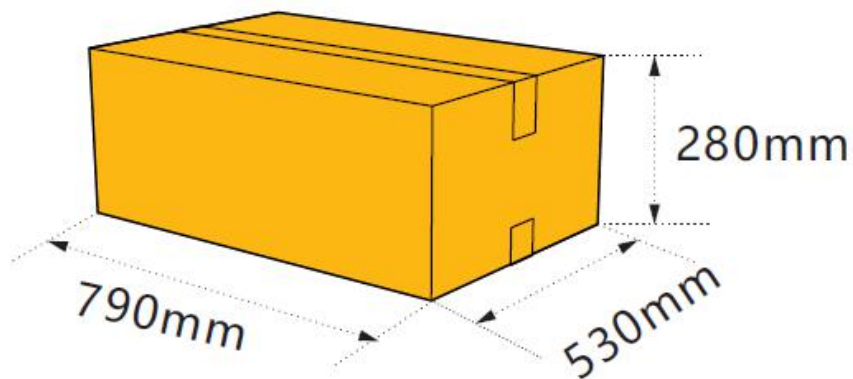

The packaging size of a single energy storage battery module and PCS module is 790*530*280.

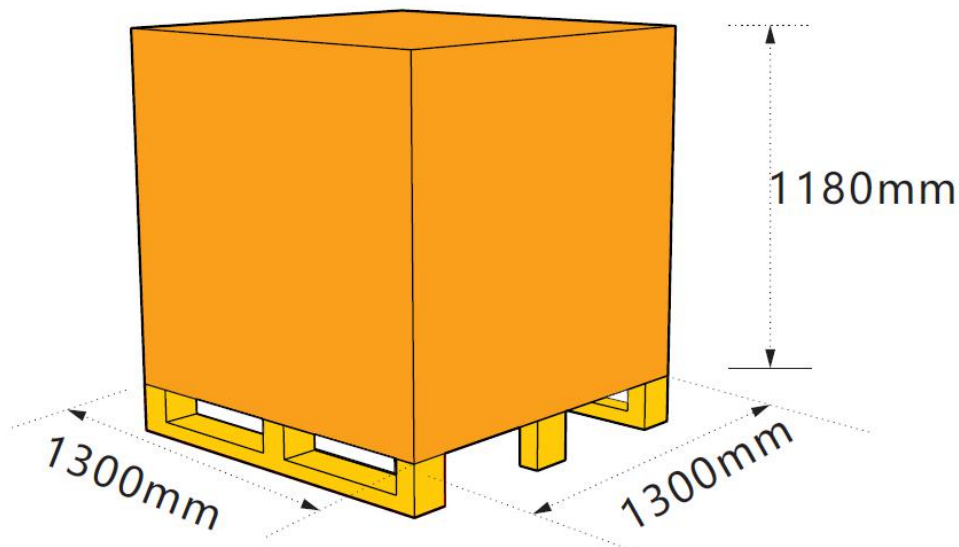

The energy storage battery module and PCS module are packed in wooden cases with the size of 1,300*1,300*1,180, the number of packs is 16PCS, and the total weight is 900Kg.

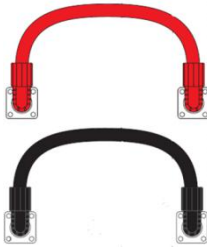

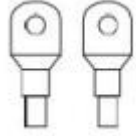
10.3 Accessories

No.	materials	picture	quantity	Storage location
1	Parallel connection cable of energy storage		1	Battery
2	Signal line of energy storage		1	Battery
3	Ground wire		1	Battery
4	Wiring ring		6	PCS
6	User Manual		1	PCS